

## High-speed double diode BAV70

### Features

- Small plastic SMD package
- High switching speed: max. 4 ns
- Continuous reverse voltage: max. 75 V
- Repetitive peak reverse voltage: max. 85 V
- Repetitive peak forward current: max. 450 mA

### Applications

- High-speed switching in thick and thin-film circuits.

### Description

- The BAV70 consists of two high-speed switching diodes with common cathodes, fabricated in planar technology, and encapsulated in the small SOT23 plastic SMD package.

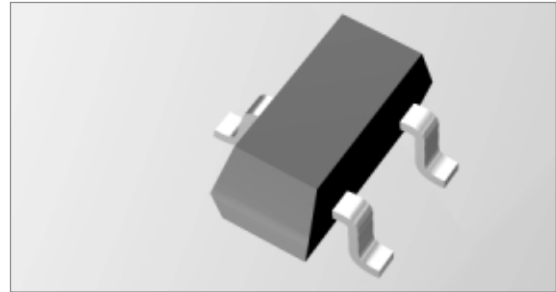

### Pinning

Pin	Description
1	anode (a1)
2	anode (a2)
3	common cathode

### Marking

Type Number	Marking Code
BAV70	A4*

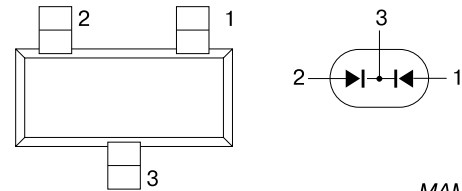

MAM383

Fig.1 Simplified outline (SOT23) and symbol.

### Limiting Values

In accordance with the Absolute Maximum Rating System (IEC 60134).

Symbol	Parameter	Conditions	Min.	Max.	Unit
<b>Per diode</b>					
$V_{RRM}$	repetitive peak reverse voltage		–	85	V
$V_R$	continuous reverse voltage		–	75	V
$I_F$	continuous forward current	single diode loaded; note 1; see Fig.2	–	215	mA
		double diode loaded; note 1; see Fig.2	–	125	mA
$I_{FRM}$	repetitive peak forward current		–	450	mA
$I_{FSM}$	non-repetitive peak forward current	square wave; $T_j=25\text{ °C}$ prior to surge; see Fig.4			
		$t=1\text{ }\mu\text{s}$	–	4	A
		$t=1\text{ ms}$	–	1	A
		$t=1\text{ s}$	–	0.5	A
$P_{tot}$	total power dissipation	$T_{amb}=25\text{ °C}$ ; note 1		250	mW
$T_{stg}$	storage temperature		–65	+150	°C
$T_j$	junction temperature			150	°C

### Thermal Characteristics

Symbol	Parameter	Conditions	Value	Unit
$R_{th\ j-tp}$	thermal resistance from junction to tie-point		360	K/W
$R_{th\ j-a}$	thermal resistance from junction to ambient	note 1	500	K/W

## Electrical Characteristics

$T_j = 25\text{ }^\circ\text{C}$  unless otherwise specified.

Symbol	Parameter	Conditions	Max.	Unit
<b>Per diode</b>				
$V_F$	forward voltage	see Fig.3		
		$I_F = 1\text{ mA}$	715	mV
		$I_F = 10\text{ mA}$	855	mV
		$I_F = 50\text{ mA}$	1	V
$I_R$	reverse current	see Fig.5		
		$V_R = 25\text{ V}$	30	nA
		$V_R = 75\text{ V}$	2.5	$\mu\text{A}$
		$V_R = 25\text{ V}; T_j = 150\text{ }^\circ\text{C}$	60	$\mu\text{A}$
$V_R = 75\text{ V}; T_j = 150\text{ }^\circ\text{C}$		100	$\mu\text{A}$	
$C_d$	diode capacitance	$f = 1\text{ MHz}; V_R = 0$ ; see Fig.6	1.5	pF
$t_{rr}$	reverse recovery time	when switched from $I_F = 10\text{ mA}$ to $I_R = 10\text{ mA}$ ; $R_L = 100\ \Omega$ ; measured at $I_R = 1\text{ mA}$ ; see Fig.7	4	ns
$V_{fr}$	forward recovery voltage	when switched from $I_F = 10\text{ mA}$ ; $t_r = 20\text{ ns}$ ; see Fig.8	1.75	V

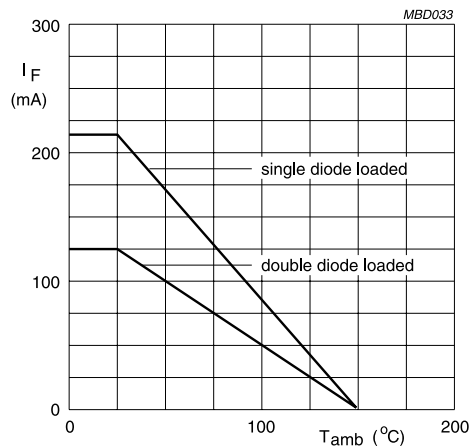

Device mounted on an FR4 printed-circuit board.

**Fig.2** Maximum permissible continuous forward current as a function of ambient temperature.

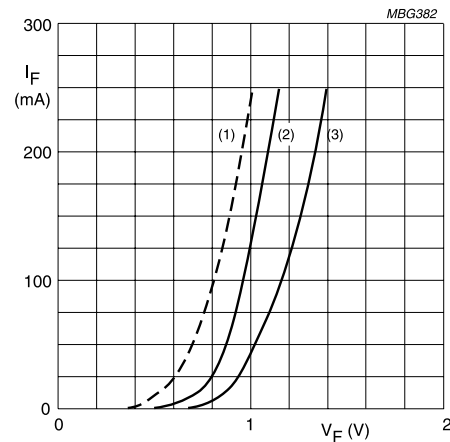

- (1)  $T_j = 150\text{ }^\circ\text{C}$ ; typical values.
- (2)  $T_j = 25\text{ }^\circ\text{C}$ ; typical values.
- (3)  $T_j = 25\text{ }^\circ\text{C}$ ; maximum values.

**Fig.3** Forward current as a function of forward voltage.

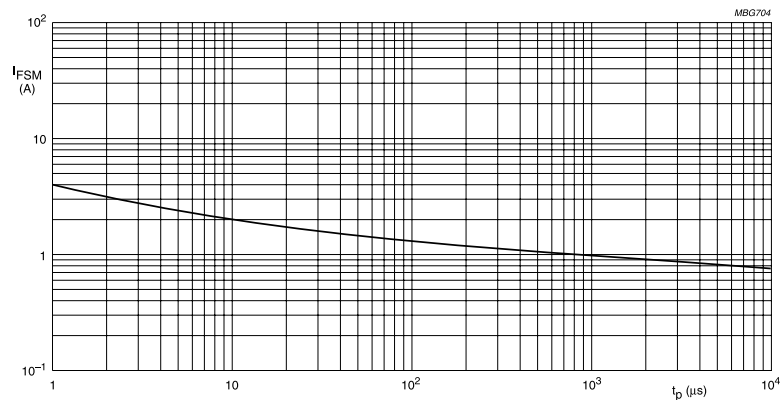

Based on square wave currents.  
 $T_j = 25\text{ }^\circ\text{C}$  prior to surge.

**Fig.4** Maximum permissible non-repetitive peak forward current as a function of pulse duration.

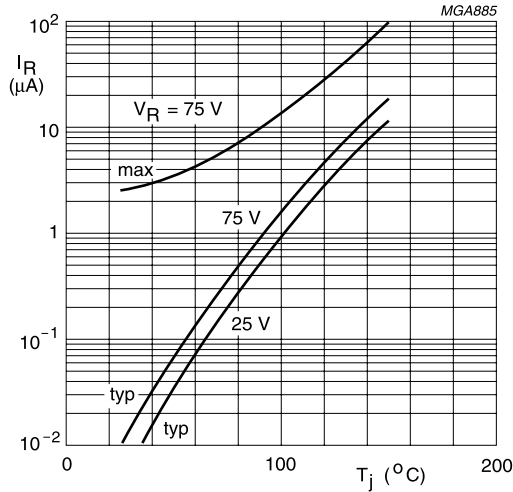

**Fig.5** Reverse current as a function of junction temperature.

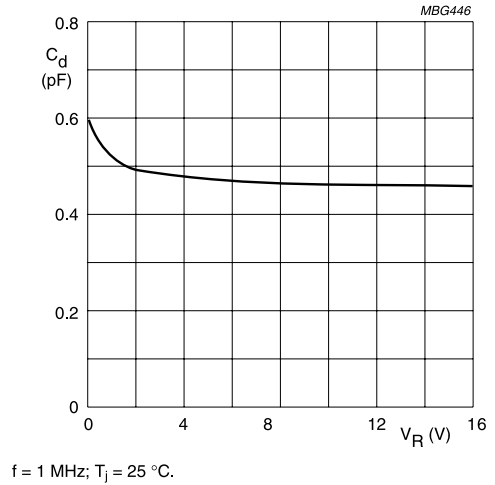
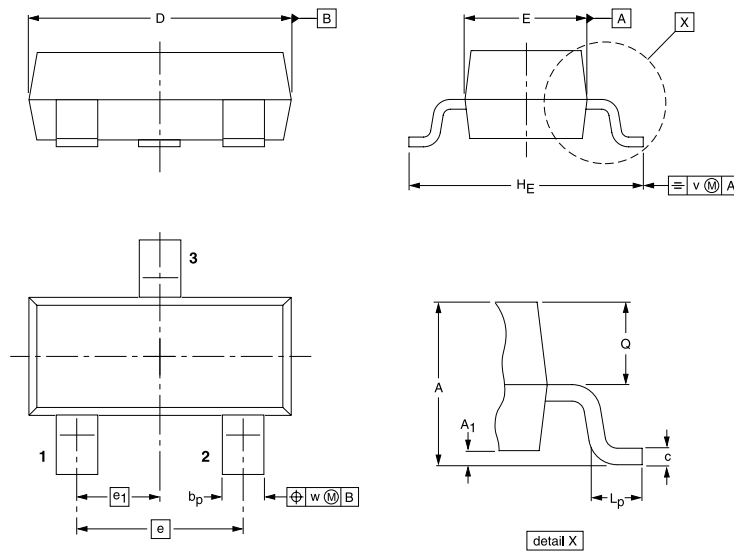

**Fig.6** Diode capacitance as a function of reverse voltage; typical values.

## Package Outline

Plastic surface mounted package; 3 leads

SOT23



### Dimensions (mm are the original dimensions)

Unit	A	A <sub>1</sub> max.	b <sub>p</sub>	c	D	E	e	e <sub>1</sub>	H <sub>E</sub>	L <sub>p</sub>	Q	V	w
mm	1.1 0.9	0.1	0.48 0.38	0.15 0.09	3.0 2.8	1.4 1.2	1.9	0.95	2.5 2.1	0.45 0.15	0.55 0.45	0.2	0.1

Outline Version	References			European Projection	Issue Date
	IEC	JEDEC	EIAJ		
SOT23		TO-236AB			99-09-13